

# SHORTWAVE BULLETIN

Issue no. 2004, June 12, 2022

Deadline e-mail next issue: 0800 UTC, June 26, 2022

In this issue there are several items in Swedish. I have found some interesting material in a few of the electronic magazines popular in the beginning of the 50'ies, Populär Radio and Radio och Television. Especially in the latter there were a DX column in each issue.

Börge Eriksson was author during quite a long time.

Borth Sven Elfving and Stig Dahlberg are considered as super DX-ers.

I also found info about an almost unknown Swedish receiver built in the beginning of the 50'ies, CEMEK. According to info from Dan Andersson only 17 were built.

One of the Swedish manufacturer of receivers at that time issued a DX book maybe to increase sales. The interest for radio in general and also for DX was huge at that time.

If you have something interesting to tell, just drop me a line with your material.

Keep on ....

=====

**R e d a k t i o n :**

*Thomas Nilsson*

*E-mail:*

[thomas.nilsson@ektv.nu](mailto:thomas.nilsson@ektv.nu)

## SWB-info

**SWB on HCDX:**

<http://www.hard-core-dx.com/swb>

**Dateline Bogotá 1993-1998:**

<http://www.hard-core-dx.com/swb/Dateline.htm>

**SWB latest issue/archive:**

<http://www.hard-core-dx.com/swb/archive.htm>

## QSL, comments, etc.

**Christer Brunström: Radio Romania International** 13750, 15460 two beautiful cards for reports in November and December last year. **Radio Exterior de España** 15520 QSL-card.

**Ron Howard**, Asilomar State Beach, Calif. Sign of the times: For many years now I have been going to my local beach to listen to SW. In the past I was normally the only car parked there in the middle of the night. Was extremely rare to have another car parked anywhere along the road by the beach.

Now it is common place to find as many as ten vehicles (mostly passenger cars, or a few small vans/SUVs) parked by the beach. People are clearly sleeping in their cars overnight, thereby saving money by not staying at a motel. Monterey is a very active tourist area and I believe most of the cars at the beach at night must just be tourists. I seem to be the only regular visitor to the beach in the middle of the night.

## En bra story om Sven Elfving.

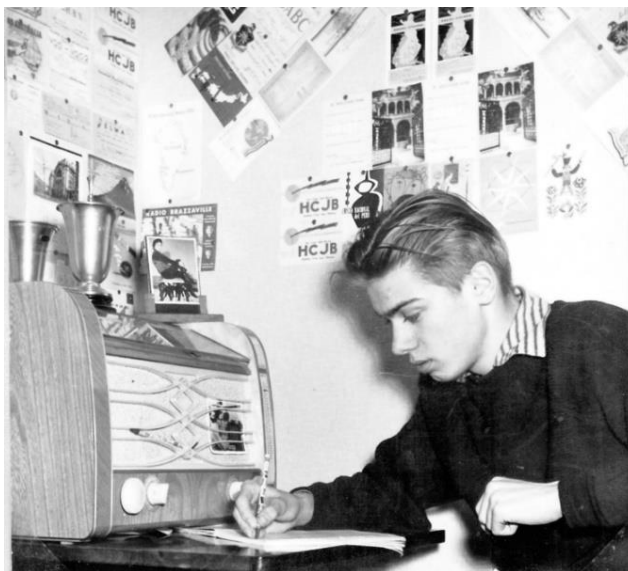

Sven Elfving, född 1940, var i sin ungdom eldsjälens bakom DX-klubben Polar Bears Radio Club i Örnsköldsvik. Sven var DX-are, FRO-are med medlemsnumret SL-3104 och så småningom värnpliktig militär telegrafist vid Jämtlands Fältjägere. Han blev dock aldrig radioamatör med eget certifikat. Hans erfarenheter från radioområdet — DX-lyssnande och amatör-radio — går dock i långa stycken utanpå det mesta. Läs hela artikeln här:

<https://www.hamnews.se/2022/05/15/sven-radioamatoren-utan-eget-certifikat-dokumenterar-minnen-fran-sina-radioar/>

Han var ju också en framstående DX-are på sin tid i Örnsköldsvik. Men också ifrågasatt då han hörde Hawaii på mellanvåg på sommaren (var det väl?).

Om detta platsar i SWB vet jag inte. Men bifogar ett foto som kan användas. Tror det är ett gammalt tidningsreportage-foto.

Bästa vårhälsningar  
(Lennart Deimert)

**GLENN HAUSER LOG ROUNDUPS.** Please note and spread the word - for those not on a list where my almost-daily all-band but mainly SW log reports appear -- or for those who are but find this a more convenient archive, weekly merged roundups of all these reports in their original form are posted early every Thursday via:

<http://www.worldofradio.com/Hauserlogs.html>

The latest ones direct: [https://www.w4uvh.net/ghlogs\\_2022\\_0602\\_0608.txt](https://www.w4uvh.net/ghlogs_2022_0602_0608.txt)

Previous issue: [https://www.w4uvh.net/ghlogs\\_2022\\_0526\\_0601.txt](https://www.w4uvh.net/ghlogs_2022_0526_0601.txt)

### Important log links:

**WOR:** <https://groups.io/g/WOR>

**SWLDXBulgaria News:** <https://groups.io/g/WOR/messages>

**WORLDWIDE DX CLUB Top News:** <https://www.wwdxc.de/topnews.shtml>

**DXPlorer:** <https://groups.io/g/DXplorer/messages>

**Liangas:** <https://zliangaslogs.wordpress.com/2022/>

**Pirates:** <https://shortwavedx.blogspot.com/2022/>

3310	Jun8	2204	R.Mosoj Chaski, Cochabamba. Quechua, tks. 2 (CGS) + (Méndez)
3325	Jun10	1503	RRI with Chinese program . Quite clear at S5 in U SB mode at 4750 only CNR is heard via Forster NSWales. (Liangas)
3480	Jun6	1200	Voice of the People; start of news in Korean ("Bodo"); 3480 (best reception, with no jamming) // 3910 // 3930 // 4450 // 6520 // 6600. (Ron Howard, Asilomar State Beach, Calif.)
3915	Jun8	2159	BBC, Kranji relay. WS in E to SEAs, IS, anns., nx. 3 (CGS)
3945	Jun4	0846	R. Vanuatu; music selections. Poor, fady, 7890 and 11835 inaudible (LOB-B).
3955	Jun8	2150	Channel 292, Rohrdorf. E, rlg. propag. 3 (CGS)
3975	Jun6	2042	Shortwave Gold, Winsen. E, pops. 3 (CGS)
3980	Jun6	1124	Echo of Hope - VOH, 3980 // 4885 // 5990 // 6250 // 6348 // 9100 (the best reception, with no jamming, but recently has been heard being jammed earlier); start of the audio feed from TV English language lesson "Wang cho bo yeong-eo", with "Mayu" and "Mini"; "I have lost my watch," "I have forgotten my password," "Thank God we have an air conditioner here!" "Thank God you are my husband!". These frequencies should be good through June 12 (Sunday). (Ron Howard, Asilomar State Beach, Calif.)
4750	Jun7	1842	Bangladesh Betar, Shavar. E, pops. 3 (CGS)
4752	Jun1	2302	R. Huanta 2000, Peru, Huanta; local music selections, ID by male "Radio Huanta"... (as can be hear in recording) "seis de la tarde y dos minutos..." ads. Poor (LOB-B).
4775.1	Jun9	2230	R.Tarma, Tarma. Cast, songs. 3 (CGS) +(Méndez)
4810	Jun2	0928	R. Logos, Peru, San Martin; pop music selections, at 0940 male comments "Radio Logos..." (as can be hear in recording). Logos transmitted their earlier tropical band broadcast only at 02/06 this past week (usually broadcast 2 or 3 times per week). STANAG underneath isn't strong enough to block Logos' signal; poor to fair, partially readable (LOB-B).
4885	Jun8	2148	R.Club do Pará, Belém PA. Advs., sports px Cartaz Desportivo. 4 (CGS)
4885	Jun10	1903	R.Echo Of Hope (cland.), Nowong-gu. Kor to KRE, tks. Jammed. 2 (CGS)
4955	May30	2243	R.Cultural Amauta, Huanta. Tks. 1 (CGS)
4965	Jun6	1846	Voice Of Hope, Makeni Ranch. E, tks. 2 (CGS) + (Méndez)
5020	Jun6	1320	SIBC, extended broadcast; still on the air with pop songs; very low modulation. Question - When was the last time SIBC was heard on 9545 kHz.? Is it ever in use now? (Ron Howard, Asilomar State Beach, Calif.)
5045	Jun6	1100	Island fm 88 with adverts then with songs. (Liangas via Rotorua NZL)
5055	Jun6	-1103*	4XZ sudden s off. (Liangas via Rotorua NZL)
5915	May30	2012	Zambia NBC Radio 1, EE talks, poor (Bernardini) + (Méndez)
5935		1300	Shiokaze/Sea Breeze; currently 5935 // 6070, during 1300-1400. Am I the only one who has noticed that it is no longer being jammed by N. Korea? Yes, it has been free of jamming for some weeks now. Wonder what happened? (Ron Howard, Asilomar State Beach, Calif.)
5938.52	May30	2115	Rádio Voz Missionária, Cambiorù, Brazil, songs talks, great id PP weak //9666.98 (Bernardini) + (CGS)
5990	Jun2	0012	the CRI relay has very undermodulated music at S7/S9+20. Something`s always wrong at RHC, RadioCuba. The other side: ``READ TODAY THE CUBA OF TOMORROW. 'Enough excuses. This is no way to live, or work' Cubans blow up over the blackouts --- The Ministry of Energy and Mines warns Cubans that 'the electric service will continue to be affected in the coming days'. DDC   La Habana May 31, 2022 ELECTRICITY Felton

Thermoelectric Plant, in Holguín. Juan Pablo Carreras (Unión Eléctrica/ Facebook) [caption]

The state-owned Unión Eléctrica (UNE) called the situation facing the National Electric Service ?complex,? while on social media Cubans are venting their weariness with the ongoing blackouts they constantly suffer, which worsened this week after the shutdown of several generation units...`

[https://diariodecuba.com/cuba/1653928851\\_39858.html](https://diariodecuba.com/cuba/1653928851_39858.html)

But supreme priority jamming against nothing unabates. However, some RHC broadcast frequencies have been unusually weak lately (Glenn Hauser, OK, WOR)

5995	Jun9	0600	Radio Mali, Bamako, 0600, Jun09, French, “La Radio Nationale”, program “Au Son du Coq”, “Au Son du Coq de Radio Mali”, news, comments, African songs. .F (Méndez) + (CGS)
6010	Jun8	2145	R.Inconfidência, Belo Horizonte MG. Anns., Jornal da Inconfidência - 2.ª edição. // 15189.993. 1 (CGS)
6070	Jun1	0703	CFRX, Toronto ON. CFRB relay, E, tks. 1 (CGS) + (Méndez)
6090	May30	1832	Amhara State Radio, Ethiopia, talks HoA style music, fair (Bernardini)
6100	Jun5	1710	TWR, Mpangela Ranch Swaziland, talks in Afican language, fair (Bernardini)
6130	May29	1742	R.Hit Mix via R.Piepzender, Zwolle. Du,pops, tks. ID via DX press. 2 (CGS)
6185	May31	0950	CHBC, heard fairly well from 0950+ UT (Mexico remains silent here). Please note the following info from Cahcn (China), posted May 31: China Huayi Broadcasting Corporation [the external broadcasting station for Taiwan/Hong Kong/Macao/South East Asia, located in Fuzhou], issued an announcement : Due to the upgrade of transmission equipment and technical adjustments, China Huayi Broadcasting Corporation shortwave <b>6185kHz will be suspended from June 1 to June 14, 2022</b> , and is expected to be resumed on June 15 broadcast. During the short-wave frequency downtime, China Huayi Broadcasting Corporation's medium wave 873kHz, Fuzhou area FM 107.1MHz, Huaguang.com ( www.chbcnet.com ), Qingting FM and other network platforms will broadcast normally, and the program content will not be affected. <a href="https://cahcn.github.io/posts/2022-05-31-6185kHz-CHBC.html">https://cahcn.github.io/posts/2022-05-31-6185kHz-CHBC.html</a> (Ron Howard, California)
6250	Jun7	1844	R.Echo Of Hope (cland.), Hwaseong. Kor to KRE, tks. QRM de jammer + uty. stn. 3 (CGS)
6340.2	Jun6	2055	Sound Of Hope R Int'l, unk. site. Mand to CHN, tks. 2 (CGS)
6370.1	Jun6	2102	Sound Of Hope R Int'l, unk. site. Mand to CHN, tks. 2 (CGS)
6520	Jun6	2100	Voice Of The People (cland.), Goyang. Kor to KRE, tks. Jammed. 2 (CGS)
7110	Jun8	-1802*	Radio Ethiopia, Geja Dera, Vernacular comments, East African songs. Strong Ham QRM. W. (Méndez)
7245	Jun9	0948	R.NZPacific, Rangitaiki. E, tks, nx. 2 (CGS) + (Liangas)
7260	Jun12	0455	Radio Vanuatu on air on 7260, Island music, English, Bislama, comments, telephone calls, mentioned "Vanatu". At 0500 slight interference from Vatican Radio with Russian program on the same frequency. (Méndez)
7270	Jun6	1041	PBS Nei Meingu with prog in Mongolian , this pronunciation is the lightest among of the heard so far (Liangas via Mawi HW)
7355	Jun6	1048	R Japan in English with news then with weather forecast. In the eibi list is noticed is also program same time. 1030-1050 other days in Russian Left the band with a stream similar to Link 11 format. (Liangas via Mawi HW)
7385	Jun2	1633	PSB Xizang, Lhasa, “Holy Tibet”, English, comments, Tibetan songs. W. (Méndez)
7810.1	Jun8	2206	Sound Of Hope R Int'l (?), unk. site. Tks, presum. in Mand (to CHN). 1 (CGS)
9155	Jun9	2238	Sound Of Hope R Int'l. (?) unk. site. Mand (to CHN), tks. Sounds too strg. for TWN, so probably CHN instead. 2 (CGS)
9330	Jun4	0500	WBCQ/World's Last Cance Radio providing a strong signal into Northern Europe and with programming in English. 3-4 (CB)
9550.1	Jun7	2036	R.Boa Vontade, Pt.º Alegre RS. Rlgs. propag. // 11895.298. 3 (CGS) + (Méndez)
9667.5	Jun9	0647	R.Voz Missionária, Camboriú SC music S7/S9, again jumped way above 9667 after last check just above nominal 9665 (Glenn Hauser, OK) + (CGS) + (Bernardini)
9670	Jun3	2100	Channel 292 with Cruising the decades, a very nice music show. 3 (CB)
9730	May28	1725	Voice of Vietnam, Hanoi-Sontay, Vietnamese to Europe, good (Bernardini)
9765	May30	2100	MWV Palavra Alegre, Mahajanga Madagascar, Portuguese religious, fair (Bernardini)
9965.18	Jun3	2143	Voz Missionaria, Camboriu Brasil, religious talk Portuguese, good off at 2107 (Bernardini)
11610	May31	2214	Radio Fedá, Mahajanga Madagascar, talks in Arabic, very good (Bernardini)
11665	Jun9	0944	Wai FM via RTM, Kajang. Tks, songs 3 (CGS)
11750	May28	1655	SLBC City FM, Trincomalee Sri Lanka, usual program with ids and web URL, very good (Bernardini)

11790 May28 1700 Adventist World Radio, Talata Volonondry Madagascar, Swahili talks to Tanzania, very good (Bernardini)

11815 Jun6 2041 Radio Brasil Central, Goiania, Brazilain songs, comments, id. "Radio Brasil Central". F. (Méndez) + (CGS) + (Bernardini)

11835H Jun6 \*0559- Radio Vanuatu, \*0559-0733. Outstanding reception; very readable; fairly easy to follow what is being said in Bislama, as there are a good number of English words used. I find this station to be very entertaining!  
0623: Information about the celebrations taking place in the UK for the Queen reigning for 70 years; mentions Vanuatu's independence in 1980.  
0629: Announcement in English for media training ("special course"); requested cover letters be sent to ABC Australia ("ABC.net.au"). Brief audio attached.  
0631-0640: Usual segment of "messages" in Bislama; job available with the Customary Land Management Office of Ministry of Justice and Community Service; gave names and info for all ten applicants for the job; segment started and ended with indigenous drums. My six minute audio posted at <https://bit.ly/3tkeRKh> . Nicely readable!  
0644: Detailed election results from the recent Samoa election; Qantas has just resumed flights again between Australia and New Caledonia.  
0650: Solomon Islands received US\$130M for airport and infrastructure improvements from the World Bank.  
0656: repeat of 0629 media training announcement; commercial for "IDA Pacific" pharmaceutical company, distributor of "IDA Foundation" products (often heard).  
0700-0717: News/sports in Bislama (lengthy item about China/Vanuatu relations, etc.).  
0731: Health program with discussion in Bislama about how to tell the difference between having a "flu" or "influenza."  
(Ron Howard, Asilomar State Beach, Calif.) + (Glenn Hauser) + (Méndez)

11880 May31 2230 Radio Habana Cuba, start bc in Portuguese, news, fair (Bernardini)

11885 Jun3 2130 Voice of Vietnam, Hanoi-Sontay, start English program to Europe, very good //9730 fair good (Bernardini)

11895.3 Jun7 2038 R.Boa Vontade, Pt.º Alegre RS. Rlgs. propag. // 9550.123. 3 (CGS)

11965 Jun3 2057 African Pathways Radio with a report on how to write the perfect reception report and on how to request a QSL-card. 4 (CB)

11985 May25 1720 Radio Free Asia, Saipan/Agingan Point N. Mariana Islands, in Korean, talks, good (Bernardini)

15190 Jun6 2040 R.Inconfidência, Belo Horizonte MG. Px A Hora do Fazendeiro. 3 (CGS) + (Bernardini)

15200 May28 1630 KTWR Trans World Radio, Guam, Ukrainian service, talks songs, very good (Bernardini)

15450 May30 0955 FEBA Manila, Philippines, end bc in Mongolian, weak (Bernardini)

15450 May30 1000 AWR, Station KSDA, Agat Guam, start bc in Chinese, weak (Bernardini)

15475.98 Jun11 1423 RCUSB, Saturday June 11 at first check 1423, no signal yet from LRA36 into Bs As remote, nor at 1453 vs S3/S4 noise level on it; and still not at 1500. 1508 checking Campo, Brasil remote; 1510 Brasília is now getting it JBA S1/S2, so back to Bs As where it's much better, S6/S7. Has just signed on late as often haphazard. 1511 Antártida themesong. 1514 canned ID as ``Radio Arcángel San Gabriel, Base Esperanza, su compañía``, omitting ``Nacional`` unlike all the others, song. 1518 the YL DJs finally come on ``live``, greeting listeners to sexto programa of 2022 season, i.e. the same one we heard on Wednesday. One of the YLs has a noticeably higher-pitched voice. Geo coordinates -- they always mention that. Base was founded on 17 December 1952. Current clima temp was: minus 1 C, warm enough to caminar = walk around outside.  
Abruptly cut off air 1522\* until cut back on at \*1531 during song.  
1536 another new? canned ID by OM voice. 1537 efemérides = this week in history including 1980? first TA flight from Bs As to Auckland NZ.  
Then about Maldivas: not an hour can go by without discussing those islands that Argentina is obsessed with. 1545 song. 1547 canned ID, acknowledging listeners in Italy, Argentina, Colombia. 1551 contact info. Signal is peaking now, VG, so that my fluency with Argentine Spanish rather than reception is the limiting factor. 1553 a bit more Malvinas history. Who would win a referendum among inhabitants, I ask?  
1600 music. 1606 canned ID, now fading a bit, repeat temp as minus one. Says today`s = June 8 amanecer was 10:18 local = 1318 UT. Primary meaning of amanecer is sunrise, but could be loosely confused with totally different dawn, really alborada. gaisma.com agrees about 1320 for SR, while sunset would be 1813 UT; she also mentioned SS but could not catch it. 1611 contact info again; 1617 citing significant dates for military or geopolitical events: 1952, 1954, 1957, 1961, 1964

Signal now S5/S9 caused not by fading but by USB modulation. 1628 mentions ``próximo programa`` so probably about to close, song. 1633 ID and staff list, ``Nacional nos une``, music until cut off at 1635\*.

Typical clumsy operation. Left it on until 1700 in background, but no more. Nor any sign of an 1800 repeat as alleged, no signal at 1830 check.

Once again I lament the lame crutch they employ, citing so much historical info rather than what is going on \*now\* or recently at Esperanza or other outposts. FWIW, [https://en.wikipedia.org/wiki/Esperanza\\_Base](https://en.wikipedia.org/wiki/Esperanza_Base)

says ``Research projects include: glaciology, seismology, oceanography, coastal ecology, biology, geology, and limnology`` but with no details at all.

Gary Pence, Dallas, tells me, ``Hi Glenn, I guess they just went QRT mid song. I was listening thru LU4AA as well. QRT at 1635z. Heard also on KFS Halfmoon Bay, CA. Heard one S unit above an S4 noise floor, best between 1530 and 1600z`` (Glenn Hauser, OK, WOR)

15625 May31 2200  
15720 Jun8 2210

AWR, Station KSDA, Agat Guam, start bc in Chinese, good (Bernardini)  
R.NZPacific, Rangitaiki. E, nx, ABC [AUS] px in Vns for Melanesia. 3 (CGS) + (Bernardini)

### Contributors to the log:

wb, Wolfgang Büschel, df5sx, wwdxc BC-DX TopNews, DXLD, DXPlorer, A-DX Glenn Hauser, Enid, OK, USA (also from WOR/DXLD) (LOB) Lúcio Bobrowiec, Embu SP, Brasil Giampiero Bernardini, Milan, Italy	CG/CGS, Carlos Gonçalves, Lissabon, Portugal Manuel Méndez, Lugo, Spain Ron Howard, Asilomar State Beach, CA, USA, WOR/DXLD Zacharias Liangas, Thessaloniki, Greece, several KIWI's CB, Christer Brunström, Halmstad, Sweden
---	--

## Station news

**ANTARCTICA [NON!]** The British Antarctic Survey's Midwinter broadcast to staff based in Antarctica will be going ahead as usual on 21 June. Frequencies unconfirmed as we go to press, last year's broadcast was carried from 2130-2200 on 6035-dha 6170-asc 7305-wof and 9505-wof. A slightly shorter version is likely to be aired from 2132-2200 on some BBCWS streams including via DAB in the UK. The only regular BBCWS English SW frequencies on the air at this time are 11810-wof and 12095-asc to West Africa but it's not currently shown in the WS schedule to Africa.

In an email to Alan Pennington on 26 April, Emily Neville, Communications and Engagement Manager with the British Antarctic Survey confirms that the broadcast will go ahead this year.

Richard Hollingham at Boffin Media who produce the show also confirmed there will be a broadcast again. Details will be circulated on the BDXC-News list as soon as we have them. If you are not yet subscribed to the BDXC-News list send an email to [bdxc-news-subscribe@groupos.io](mailto:bdxc-news-subscribe@groupos.io)

(via WOR)

**NETHERLANDS.** Så er **Sunlite** på 5955 kHz (200 W) fra Nederlandene fremover kun i luften kl. 0400-1800 UTC. Sunlite er en legal station, der sender fra Westdorpe i Zeeland, nær grænsen til Belgien.

Det forlyder J.. at man om aftenen – fra kl. 1800 UTC i stedet kan høre Deltracks. Deltracks er en piratstation. Sender fra en – i sagens natur – ukendt sendeposition antageligt i Nederlandene.

(Stig Hartvig Nielsen via WOR)

**TAIWAN.** New Religious Station in Chinese (1130-1200UT Wed/Sat 11925kHz Tamsui 300kW 285deg) responded my E-mail reception report (sent to < info @ rongyaoshenghuo.com >) in Chinese. According to their E-mail in Chinese, the station name is “Shenghuode huayu guangbodiantai” (生活的话语广播电台), meaning “The discourse of life radio station”. They say their object is to share the Gospel with Chinese people by broadcasting through shortwave radio. They sent me the pdf booklet by Pastor Chris Oyakhilome, who is the founder and president of LoveWorld Incorporated (Christ Embassy), both in Japanese and Chinese. This Christian religious organization, whose HQ is in Nigeria, is active in UK, Canada, Australia, and USA. By the way “rongyao shenghuo” (荣耀生活) means “glorious life”. They also informed me of the recent change of frequency from 21500kHz to 11925kHz.



In their URL <http://www.rongyaoshenghuo.com>, past programs in Chinese are available, but there is no mention about shortwave broadcasting. The promotion video in Chinese of the opening of shortwave broadcast (on 21500kHz at first) is found at YouTube <https://www.youtube.com/watch?v=KMOpFiwoN1o>, uploaded on April 16 2022.  
(Takahito Akabayashi, Tokyo, Japan via WOR)

**USA.** The program schedule and Listen Again/podcasts of the African service of the VOA have been moved from <https://www.voanews.com> to <https://www.voaafrica.com>. There are issues with the new website, however, with many on-air programs not getting listed.

I finally found the daily schedule at <https://www.voaafrica.com/radio/schedule/435>, but there are gaps. For example "Border Crossings" at Monday-Friday 1505UT is not listed, neither is "Straight Talk Africa" on Wednesday at 1830UT. I suspect this is because these programs, although aired in the African service, are not produced by VOA Africa ("Border Crossings" is a VOA Global production, whilst "Straight Talk Africa" is a VOA Africa TV production). Not very helpful for listeners.

Of course, there are no frequency schedules given either. There is a frequency schedule at <https://www.voanews.com/p/6212.html>, but this is sadly out of date.

Anyway, the WOR Station Hitlist at <http://www.w4uvh.net/hitlist.htm> will be updated in the next couple of days.  
(Alan Roe, Teddington, UK via WOR)

## Other radio news

### R-399 "Katran" | The best receiver of the USSR.

In Russian. Video – 18:29

[https://vk.com/radioreceiver?z=video-163779953\\_456243203%2F29d3638887324f6bf9%2Fpl\\_wall\\_-163779953](https://vk.com/radioreceiver?z=video-163779953_456243203%2F29d3638887324f6bf9%2Fpl_wall_-163779953)



One of the last all-wave receivers of the USSR. It is still in demand and relevant.

This receiver at our collective station was a gift from Gemeshev A.I. with the assistance of Zalatov A.V.

Katran is a trunk professional superheterodyne communication radio receiver

receiver R-399A operating in the HF band, belongs to third-generation radio equipment, designed to search for and receive TLF, TLG and single lane transmissions.

Detailed information about the receiver here: [http://www.cqham.ru/trx/r\\_399.html](http://www.cqham.ru/trx/r_399.html) Donate to the QIWI laboratory (by nickname) - PACWN683

<https://vk.com/radioreceiver>

(RUS-DX #1189)

### [WOR] FCC to Consider Expanding FM Radio to 82-88 MHz, Replace TV Channel 6

Oh, just we need: more right wing political ranting, a further slice and dice of rick music “genres”, another sports talk network, maybe a channel or two devoted entirely to sports betting. In other words, just more of the same.

The trouble with FM radio is the product. It’s lowest common denominator stuff — no creativity and all designed to service a huge debt load. Instead of the FCC treating FM like a vital medium instrumental in disseminating vital information and serving all types of audiences, it has acquiesced to commercial interests who treat it as just another commodity whose primary reason to exist is to serve advertisers. In that regard, it has permitted commercial ownership to so overextend itself financially that the product suffers as a result.

Frankly, if the FCC wants to encourage an FM revival, it should reduce the number of licensees, not increase them and then reimpose concentration of control restrictions. More iHeart isn’t the solution.

(John Figliozzi via WOR)

## DUX DX-BOK från 1951

Under 50-talet var D-intresset stort och Dux Radio AB gav ut en bok på c:a 70 sidor om DX-ing, det var tider det!



# DUX DX-BOK

om utlandslyssning  
ger mer  
radiogladje

Vet Ni vilken tjugande hobby utlandslyssningen är? Vet Ni hur lätt det är att komma i kontakt med fjärran länder och folk, även utan språkkunskaper? Vet Ni vilka utländska stationer som sänder på svenska? Om allt detta och mycket annat kan Ni läsa i den nytänkta *DUX DX* - bok om utlandslyssning som lär Er hur man får större glädje och behållning av radiolyssningen. Den innehåller, förutom rikt illustrerade artiklar, världens mest utförliga våglängdstabell med uppgifter om över 2.000 radiostationer samt en världskarta i flerfärg i väggformat 70x40 cm. *Pris kr 3:50* i bokhandeln, radiohandeln samt i pressbyråns kiosker. Boken kan även rekvideras från

**DUX RADIO AB**  
Svarvargatan 11, Stockholm  
\*DX = int. förkortning för distanslyssning.

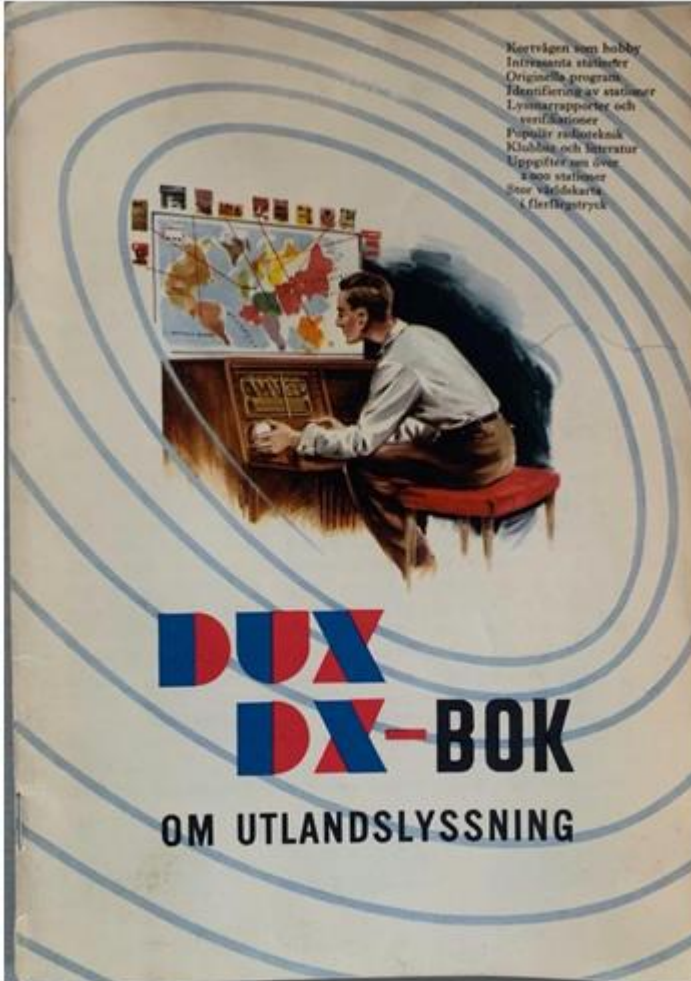

Keotvågen som hobby  
Intressanta ställningar  
Originala program  
Identifiering av stationer  
Lyssningsrapporter och  
verifikationer  
Populär radioteknik  
Klubbar och literatur  
Uppgifter om över  
2.000 stationer  
En världskarta  
i flerfärgstryck

# DUX DX-BOK

OM UTLANDSLYSSNING

[https://www.aef.se/Amatortidningar/Popular-Radio/Year\\_1950-1953/Popular\\_Radio\\_1952\\_nr\\_1.pdf](https://www.aef.se/Amatortidningar/Popular-Radio/Year_1950-1953/Popular_Radio_1952_nr_1.pdf)

## “Jazz from the heart of America”, VOA, June 3, 2022

On June 5, 2022, Voice of America will launch a new jazz program in partnership with WDCB, a non-commercial radio station operated by the College of DuPage in Glen Ellyn, Illinois.

“Jazz from the heart of America” will be hosted by WDCB Station Manager Dan Bindert and will feature a weekly hour-long radio program of jazz music of today and yesteryear to air on FM and shortwave radio stations and VOA affiliates’ platforms around the world.

VOA Executive Producer for Music June Simms is very excited about the partnership. “Jazz has long been a part of VOA’s legacy and we are thrilled to continue the tradition of Willis Conover and jazz programming with WDCB.”

VOA’s interest in jazz dates back to VOA international jazz icon, Willis Conover, affectionately known as America’s “ambassador of jazz,” whose career spanned more than four decades since his popular show, “Music USA,” hit airwaves on January 6, 1955. Back then, jazz programming was an important tool showcasing America’s talents and arts, breaking through the Iron Curtain. Conover’s program featured interviews and performances from world-famous American jazz artists such as Dizzy Gillespie, Duke Ellington, Sara Vaughn, Louis Armstrong, and Ella Fitzgerald.

“Jazz has been a staple at VOA for decades, helping to tell America’s story,” explained Acting VOA Director Yolanda López. “I’m excited to continue this legacy working with WDCB in Chicago as they share great jazz music throughout the world.”

“Jazz from the heart of America” will air for the first time Sunday, June 5 at 0700 UTC.

<https://www.insidevoa.com/a/a-new-era-of-jazz-programming-begins-at-voa/6602540.html>

(Mike Terry via WOR)

## [WOR] NASWA FRENDEX archive

World Radio History What's New Page: June 3 FrenDX from NASWA Added one issue from 1962, 9 issues from 1971 and three issues from 1972. June 6 Added over 400 issues of FRENDEX from the 1970s. from the North American Shortwave Association. Over 150 more to come in next few days. We have scanned over 15,000 pages of this publication and they will all be available soon. They will soon be searchable, too!

[https://worldradiohistory.com/NASWA\\_FrenDX.htm](https://worldradiohistory.com/NASWA_FrenDX.htm)

A valuable historical resource. Just done a search and it is now active.  
(Mike Barraclough via WOR)

## The largest and most powerful radio transmitter, which is located in the village of Raduzhny, is planned to be closed. Video in Russian - 3:10

[https://vk.com/public158109176?z=video-158109176\\_456239309%2Fbe1be17e3c67bdfb24%2Fpl\\_wall\\_-158109176](https://vk.com/public158109176?z=video-158109176_456239309%2Fbe1be17e3c67bdfb24%2Fpl_wall_-158109176)

In Soviet times, powerful broadcasting radio centers were often built far from populated areas. Literally from scratch, a transmitting facility was erected and a new settlement appeared on the map with residents-workers of the radio center. With all infrastructure, social institutions. People lived here for years, labor dynasties appeared.

I note that until 1988, a number of radio centers, in addition to broadcasting radio programs, were engaged in jamming "enemy" voices.

That is, there was enough work. After the collapse of the USSR, in Russia the centers remained "afloat" due to the internal LW / MW / SW broadcasting of state radio stations and foreign broadcasting, as well as retransmission of programs from various companies.

In 2013 - 2015, there was a global reduction in analogue broadcasting in Russia. Mayak was the first to leave, then the Voice of Russia and, ultimately, Radio Russia. For FSUE RTRS (an organization in charge of radio centers), this has become a big problem. Transmitting facilities have been placed on conservation. The staff at many centers has been reduced to a minimum (security)

Radio centers with an unclear future and, in fact, of no use, stand around the country in varying degrees of safety. Unfortunately, in the vast territories of the centers it is impossible to keep track of everything, and antenna systems, feeder lines die at the hands of marauders, bringing the transmitting objects into final disrepair.

People hurt the most. When after conservation (in fact, the closure) of the radio center, the village is doomed to its historical decline.

We leave for the Magadan Region. Olsky district. Rainbow village. In 1967, Radio Station No. 7 was put into operation here. Broadcasting in the ranges of LW and SW. It was.

In 2015, the center was mothballed, and the village of Raduzhny was recognized as unpromising and subject to resettlement.

(Andrey Molokov, <https://vk.com/public158109176>) (RUS-DX #1187)

## 25. Sonnenzyklus übertrifft Vorhersagen

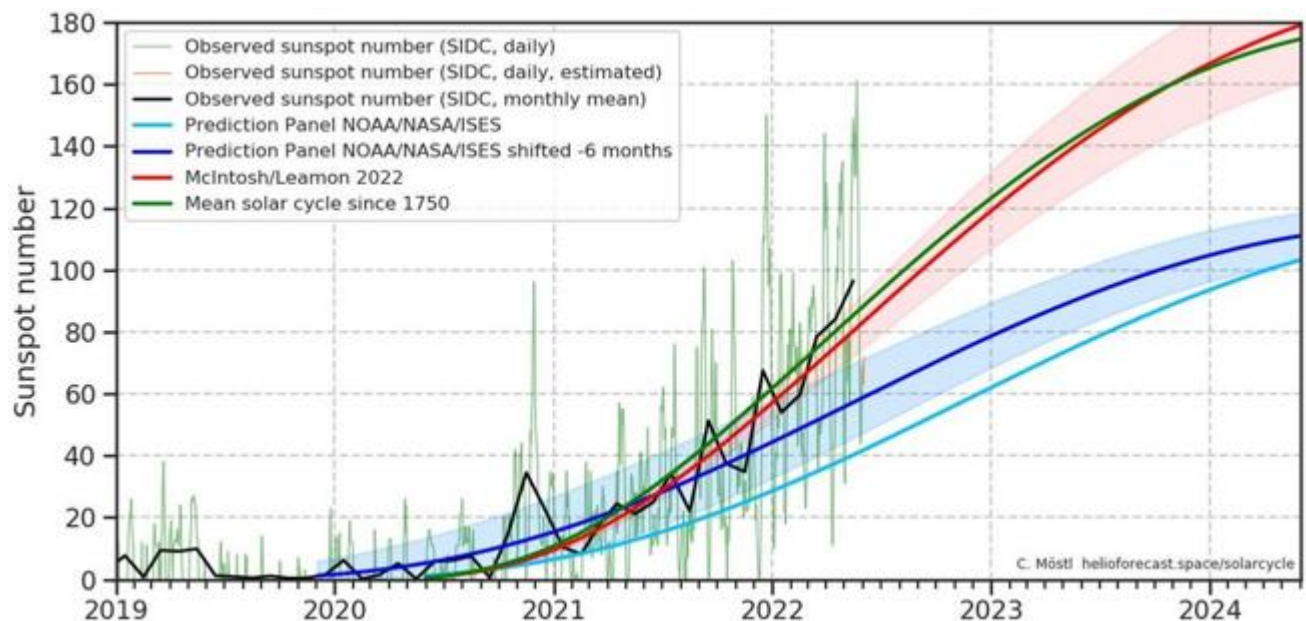

Die Sonnenfleckenanzahlen im Mai 2022 liegen doppelt so hoch wie in den Vorhersagen der US-amerikanischen Wetterbehörde NOAA und legen ein relativ starkes Sonnenmaximum Anfang 2025 nahe.



Die Grafik stammt von Helio4cast, einer Gruppe von Wissenschaftlern mit Sitz in Österreich, die sich mit Grundlagen- und angewandter Weltraumwetterforschung befasst. Sie vergleicht die tatsächlichen Sonnenfleckenzahlen mit einer Auswahl von Referenzwerten. Die blaue Kurve ist die "offizielle Vorhersage" des Solar Cycle Prediction Panel der NOAA im Jahr 2019. Die aktuellen Sonnenfleckenzahlen liegen deutlich höher diese. Die grüne Kurve ist der Durchschnitt aller Sonnenzyklen seit 1750, und die rote Kurve ist eine neue Vorhersage auf der Grundlage des Termination Event. Die aktuellen Sonnenfleckenzahlen stimmen mit beiden überein. Selbst wenn der Solarzyklus 25 nur durchschnittlich ausfällt, wird er die bisher niedrigen Erwartungen weit übertreffen.

(Quelle: SpaceWeather.com / Helio4Cast / bearb.: DF5JL via A-DX Fernempfang)

## OVANLIG SVENSK KOMMUNIKATIONSMOTTAGARE - CEMEK CEA 53 (SN 115)

### Mottagare för DX-lyssnare



**CEMEK trafikmottagare typ CEA53 helt svensktillverkad med modernaste rörbestyckning och i gediget mekaniskt och elektriskt utförande.**

**9-rörs dubbelsuperheterodynu m. 12 rörfunktioner.**

**Frekv.-omr.** 550 kp/s—35 Mp/s i fyra band. Noggrannhet  $\pm 0,1 \%$ .

**Skala.** Handkalibrerad, kuggväxeldriven. 330 gr. vridn.-vinkel. Elektrisk bandspridning.

**Känslighet.** I medeltal 2 mikrovolt känslighet vid ett signal/brusförhållande av 10 dB. Spegelbildsdämpning —50 till —80 dB beroende på frekvensband.

**Bandbredd.** Denna är reglerbar medelst omkopplare i två lägen. Smalaste läget har  $\pm 1,5$  kp/s vid 6 dB och  $\pm 4$  kp/s vid 60 dB.

**Övriga data.** S-meter — Inbyggd 5" högtalare — Antenntrimmer — Beatoscillator — Hf kontroll — Tonkontroll — Stabiliserad anodspänning m. m.

**Mek. utf.** Frontpanel av 5 mm aluminium med graverad text. Stabil chassi med väl tilltagen skärmning. Dimensioner: 500X220X180 mm.

**Pris.** Kronor 950:— netto.

Närmare upplysningar erhålles direkt från fabrikanter:

**INGENIÖRSFIRMA CEMEK**

Vegagatan 20, Solna - Tel. 82 08 90.

Satt och kollade igenom några gamla Radio & Television från början av 50-talet och snubblade över en annons på en svensk kommunikationsmottagare jag aldrig hört tals om, en CEMEK CEA53. Det fanns inte heller någon information att hämta på nätet. Varje sökning visade i stort sett bara annonsen.

Man kunde se att Ingenjörfirmen CEMEK producerade signalgeneratorer som sin största produkt. Det ser ut som den här mottagaren är byggd på samma chassi som signalgeneratorerna.

En fråga gick i väg till Dan Andersson som råkade ha den här mottagaren i sin samling och han skickade över bilder och lite mer information.

I QTC från 2004 nr 7-8 hittades denna annons: "Trafikmottagare Cemek CEA 53 ser.nr 115 (svensk. 50-tal). Pris 600:-"

Som av en händelse är det just den som Dan Andersson fått tag på. Enligt Dan lär också Kjell Bengtsson ha en sån ovanlig sak i sin stora samling av kommunikationsmottagare. Dan Andersson har för sig att det sista exemplaret som byggdes har stått på radiomuseet i Göteborg och den var ej färdigbyggd! Det

skall visst vara serienr 116 eller 117.....!?

[https://www.aef.se/Amatortidningar/Radio\\_och\\_Television/radio\\_television\\_1954\\_10-ocr.pdf](https://www.aef.se/Amatortidningar/Radio_och_Television/radio_television_1954_10-ocr.pdf)





RÖR: 0D3, ECL 80, EABC 80, ECC 81, ECH 81, EF 43, ECF 80 samt EF 43

PÅ BURKARNA FRÅN VÄNSTER SETT:  
 OSC 1725, MF 110, MF 1615, MF 1615  
 Det finns en kristall som sitter mitt i  
 radion 999,951 KHz Den sitter högst upp!  
 Högtalare är en Goodmans

Stort tack till **Dan Andersson** för bilder och kommentarer. /TN



### **The US State Department urged not to disconnect Russia from the Internet.**

State Department spokesman Ned Price said the United States is opposed to Russia's disconnection from the global network.

"We urge involved players around the world not to disconnect Russia from the Internet," he said during a regular briefing. Price explained that according to Washington, information should continue to flow to Russia ...

([https://www.mk.ru/politics/2022/05/25/gosdep-ssha-prizval-ne-otklyuchat-rossiyu-ot-inter-neta.html?utm\\_source=yxnews&utm\\_medium=desktop](https://www.mk.ru/politics/2022/05/25/gosdep-ssha-prizval-ne-otklyuchat-rossiyu-ot-inter-neta.html?utm_source=yxnews&utm_medium=desktop))

(RUS-DX #1187)

### **The head of the satellite communications and radio communications department of Skvortsovo gave an interview to the Far Eastern Electronic Newspaper.**

In April, Mikhail Kachka, head of the satellite communications and radio communications workshop at Skvortsovo, gave Gennady Vedernikov, editor-in-chief of the Far Eastern electronic newspaper, a tour of the facility. Mikhail Kachka told the reporter how the Far Eastern RC branch of the RTRS lives and what the specialists do.

Gennady Vedernikov wrote an article that will be included in the historical chronicles of the branch. Here is the text in full...

Details in Russian - <https://khabarovsk.rtrs.ru//prof/rtrs-region/newspaper/teleport-v-nebo-dfo-glavnyy-redaktor-dalnevo-stochnoy-elektronnoy-gazety-gennadiy-vedernikov-vzval-in/>

(<https://moscow.rtrs.ru/>)

(RUS-DX #1188)

### **Ruselectronics will supply equipment for radio broadcasting to Kazakhstan.**

The Roselectronics holding of the Rostec State Corporation will supply equipment to the Republic of Kazakhstan to ensure the broadcasting of a new Kazakh radio station. Due to the use of modern element base, modular structure and new technical solutions, the devices have increased reliability and fault tolerance, notes in Ruselectronics...

Details - [https://telecom.cnews.ru/news/line/2022-06-02\\_roselektronika\\_postavit](https://telecom.cnews.ru/news/line/2022-06-02_roselektronika_postavit)

(Valeriy / Radio reception - / Telegram)

(RUS-DX #1188)

### **Roskomnadzor announced the restriction of the work of Proton VPN and other services.**

Moscow. 2 June. INTERFAX.RU - Roskomnadzor confirmed that within the framework of the law on the "sovereign" Ru-net in Russia, work is underway to block VPN services, including Proton VPN, which help bypass blocking of content recognized in the Russian Federation as prohibited.

"According to the law "On Communications", the means of bypassing the blocking of illegal content are recognized as a threat. The Center for Monitoring and Control of the Public Communications Network (TsMU SSOP) is taking measures to limit the operation of VPN services in Russia that violate Russian law," the department said. Interfax" in response to a request regarding problems with user access in Russia to the Proton VPN service ...

Last year, more than a dozen popular services were restricted in the Russian Federation, in particular, ExpressVPN, NordVPN, Hola!VPN, IPVanish VPN, KeepSolid VPN Unlimited, Speedify VPN. The RKN leaves the possibility of using these services only for companies from the so-called "white list", which have informed the agency that they need these VPNs in their work. The list of such companies can grow. In December 2021, it was reported that the RKN intends to

restrict the work of six more VPN services in the Russian Federation: Betternet, Lantern, X-VPN, Cloudflare WARP, Tachyon VPN, PrivateTunnel.

As reported, Opera, in response to the restriction of its VPN service in the Russian Federation, turned off the VPN function in its browsers in Russia ...

(<https://www.interfax.ru/russia/844320>)

(RUS-DX #1188)

### **What to do if the VPN is not working? And what services are still running?**

Information from the Internet.

Russian users have encountered problems connecting to some VPN services. In particular, on Thursday, June 2, most people using Proton VPN were unable to access the Internet using the service. Representatives of the company said that their application is likely to be blocked in Russia.

Details - <https://topdialog.ru/2022/06/03/cto-delat-esli-ne-rabotaet-vpn-i-kakie-servisy-prodolzhayut-funkcionirovat/>

(Konstantin Barsenkov, St. Petersburg, Russia)

(RUS-DX #1188)

### **NEW HISTORY MATERIAL AT <<http://www.ontheshortwaves.com>>**

If you were DXing as “recently” as the late 1990s, you probably knew the name Jack Perolo, PY2PE1C, of Sao Paulo, Brazil. Jack had been DXing since 1949, and he was a prime source of authoritative information on the shortwave DX bands, Latin American stations in particular. One of his work products, which he prepared with his friend, Jerzy Sielawa, was a 60 meter survey, published in 1974, which we have now posted (with Jack’s permission). In his introduction, Jack describes why he compiled the survey, and he gives the meanings of the various conventions used in it. What sets this survey apart is that it is cumulative: it shows, for each station, the year that it was last heard, going as far back as 1957. This represents the kind of historical record that I have not seen elsewhere for that period. It was also a practical aid to IDing new signals--if you knew who had been broadcasting on or near a given channel before, it might be the same station now. Look for the survey at the red “New” for the year 1974 in “DX History-II/Lists, Logs, Guides & Columns.” *Thanks, Jack.*

In “Specialized Resources/Wavescan,” we have listed the audio-only Wavescans that were posted in May. They are: “Voice of America Shortwave Relay Station at Poro in the Philippines” (N688, May 1); “BBC London Celebrates 100 Years: Mediumwave Station 2LO” (N689, May 8); “The Early Radio Scene in the Canadian Province of Manitoba” (N690, May 15); “Voice of America Relay Station at Tinang in the Philippines” and “Tribute to Oldrich Cip, R. Prague, Pt. I [Jonathan Marks]” [9:13] (N691, May 22); and “Powell Crosley and His Life’s Story” and “Tribute to Oldrich Cip, R. Prague, Pt. II [Jonathan Marks]” [6:43] (N692, May 29).

And the following Wavescans, previously available in audio only, have now been posted in text format: “Three International Shortwave Weddings” (N670, December 26, 2021); “The World’s First Radio Weddings, Pt. 1” and “AWA Radio in Australia: Snowy Mountains Radio” (N678, February 20, 2022); “The First VOA Relay Station in the Philippines” (N679, February 27, 2022); “The World’s First Radio Weddings, Pt. 2” and “AWA Radio Callsigns” (N680, March 6, 2022); and “The Second VOA Relay Station in the Philippines” (N681, March 13, 2022).

Finally, the year 1925 has been added to the compilation, “Wavescan--Early Years With the American Shortwave Stations, 1922-1925,” which can be found at the top of the Wavescan program list.

Under “DX History-I/Recordings,” look for the red “New” at Peru IV for another group of recordings of Peruvian stations.

(Jerry Berg via DXPlorer)

-----  
That is quite the listing put together by Jack and Jerzy back in the 1970's. When compared to the recent comparable listing form Anker Petersen it brings a tear to a DX'ers eyes (or maybe that should be to a DX'ers "ears"?). The good old days were quite good, eh?

(73, Rich D'Angelo via DXPlorer)

-----  
Yes, they were good!

In the first edition of the Tropical Bands Survey published in June 1973 by Carol Feil and me, we could count 92 active broadcasting stations between 2200 and 2500 kHz!

Today you only find two stations: Korean Central Broadcasting Station on 2350 kHz and Radio Symban, Australia, with Greek programmes.

(Best 73, Anker Petersen, Denmark via DXPlorer)

### **[mwoffsets] uploaded new article about finding offsets using KiwiSDRs**

Jeroen Bet just had a new article published in IRCA's DX Monitor about finding MWoffsets using KiwiSDRs.

I've uploaded a copy to the files area. <https://groups.io/g/mwoffsets/files/NHP/KiwiSDROffsets.pdf>

(best wishes, Nick Hall-Patch)



## [DXplorer] Radio Garden

By the way, livestreaming seems to have partly replaced shortwaves nowadays!

The Dutch/German developed "Radio Garden" shows a lot of green dots on the globe. Each dot is a city or a town with at least one broadcasting station, which can be heard with excellent reception.

Thus Africa has about 600 (six hundred) green dots !!!

Try Native Radio, Achimota in Ghana on the internet: <http://radio.garden/listen/native-radio-ntent/85BT3CPJ> .

Other green dots can be selected by using your mouse.

(Best 73, Anker Petersen via DXplorer)

## The Shared Apex Loop Array

This compact directional wideband receiving antenna can reduce interference.

Effective receiving antennas are becoming an indispensable part of our amateur arsenal as we battle interference from both natural and man-made sources.

Many of us do not have the acreage to erect directional antennas, especially on the lower bands, so we use shortened verticals and low hanging dipoles, which provide essentially omnidirectional response.

As a result, our ears are bombarded with signals and interference from all directions when our transmitting antenna doubles as our receiving antenna.

The complete article here:

[http://www.arrl.org/files/file/QEX\\_Next\\_Issue/Sep-Oct\\_2012/Bauman\\_QST\\_10\\_12.pdf](http://www.arrl.org/files/file/QEX_Next_Issue/Sep-Oct_2012/Bauman_QST_10_12.pdf)

(Mark Bauman, KB7GF)

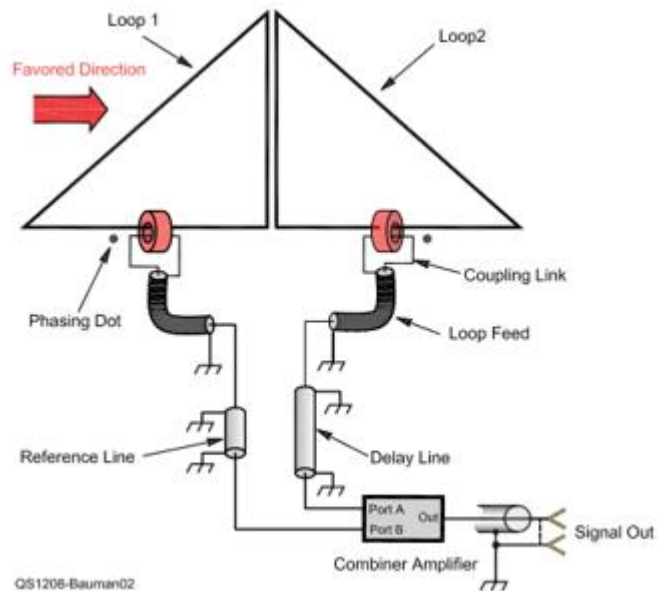

## Tropical Bands Monitor, June update

The DSWCI produced the high quality magazine "Shortwave News" (9 issues/year) and a fortnightly newsletter called "DX Window", as well as the yearly "Domestic Broadcasting Survey" with its monthly update "Tropical Bands Monitor". This website presents back issues of these publications. There is also an offer to buy the complete archive of Shortwave News (60 years!) on a DVD.

The "Domestic Broadcasting Survey" and the "Tropical Bands monitor" will be produced further on a private basis by Anker Petersen, former chairman of the DSWCI. The publications will be sent out by e-mail to everyone who wants them and also be published on this website.

Latest issue: (<http://www.dswci.org/tbmonitor/2022.pdf>)

(DSWCI)

## [nordx] Nyheter från Radiomuseet i Göteborg



Juninumret av **Nyheter från Radiomuseet** nr 161 finns nu tillgängligt för alla som vill ha det. Sänd bara ett mail till [info@radiomuseet.se](mailto:info@radiomuseet.se) så sänder vi det till den mailadress du anger. Om du vill ha med något inlägg i nästa nummer så hör bara av dig. <https://word-press.radiomuseet.se/>

(Kari Kallio via nordx)

## [nordx] Dansk radios rige historie

<https://www.youtube.com/watch?v=ar-ykJS6cCA>

<https://www.youtube.com/watch?v=evOMvOR-n44>

<https://www.youtube.com/watch?v=exjnn-nnUgs>

<https://www.youtube.com/watch?v=KaadQ4g9stg>

<https://www.youtube.com/watch?v=UDaXYW0A4TI>

<https://www.youtube.com/watch?v=G2KDy3HJmkQ&t=61s>

<https://www.youtube.com/watch?v=d2gnKyDZOzY>

(Kari Kallio via nordx)



Av svenska DX-are har kanske Stig Dahlberg flest länder verifierade, i varje fall enligt MEST statistiken från 2008.



ytterst få mottagare som gör detta annat än inom vissa områden, vilket förorsakar DX-aren en hel del räkneoperationer innan en bestämd frekvens kan inställas. Han vill dock främst framhålla, att en god mottagare visserligen är en av förutsättningarna för ett gott resultat, men det väsentliga är dock goda konditioner och tålamod. Är det fina konditioner på kortvåg spelar mottagaren en underordnad roll.

Stig Dahlberg anser, att det som mest sporrar honom till vidare ansträngningar, är de intressanta personliga kontakter han vinner via kortvågen. Genom dessa vänner runt jorden har han samlat souvenirer av de mest skilda slag samt även berikat sin stora samling av exotiska konsthantverk, han har t.ex. fått ett flertal ansiktsmasker från Afrika, och hans verkliga dyrgrip, en paradisfågel, kommer från vänner på Nya Guinea med vilka han kommit i kontakt genom DX-hobbyn. (Från Radio\_Television 1956 nr 7-8)

Kommentar: Enligt den svenska statistiken, MEST från 2008, har Stig Dahlberg samlat på sig verifierationer från 243 länder. /TN

### SM i DX-ing 1961

Även 1961 års SM i DX-ing vanns av Stig Dahlberg, Malmö, vilken efter de tre olika etapperna erhöll platssiffran 6. Tvåa blev Holger Öqvist, Malmberget med platssiffran 10 och tredje man blev fjolärstvåan Kjell Ekholm, Malmö med platssiffran 17.

Förutom de olika etappiserna fick segraren Stig Dahlberg mottaga ett vandringspris, nyinstiftat och skänkt av DX-Club 57 i Nässjö. Priset överlämnades i Malmö av klubbens representant Jan Tunér.

Troligtvis kommer även 1962 års SM att gå i etapper, men detta kommer att bestämmas på DX-Parlamentet i augusti.

(Från Radio\_Television\_1961 nr 10)

Stig Dahlberg i Luleå är en av landets mest aktiva DX-are samt en av de allra framgångsrikaste, vilket bevisas av att han lyckats hålla sig på den absoluta toppen under åtskilliga år. Hans »målkvot» torde säkert ligga bäst till i landet beträffande de senaste årens SM-tävlingar och andra riksomfattande tävlingar. Han blev helt fångad av DX-hobbyn 1948 och har sedan dess till allra största delen ägnat sin fritid åt radion och har under årens lopp tillägnat sig en otrolig skicklighet att kunna få ut det mesta ur sin mottagare.

Hans verifikationsinsamling är imponerande, han kan visa upp svar från icke mindre än 135 olika länder, bl. a. ett par första rapporter från hela världen. I hans samling av rariteter återfinnes verifikationer t.ex. från Falklandsöarna och Franska Guiana inom Sydamerika. Oceanien är trots mycket svaga och svårångade stationer väl representerat genom Tahiti, Nya Kaledonien och Nya Guinea.

Hans utrustning är i förhållande till resultatet inte särdeles märkvärdig, mottagaren är en Eddystone dubbelsuper, typ 750, med en 35 ID lång L-antenn 25 m över marken i riktning NV-SO. Med åren har han provat ett flertal olika antenner, och hans uppfattning är, att den bästa DX-antennen torde vara en ca 100 m lång L-antenn, helst då flera sådana så att olika riktningar kan väljas. Försök har även gjorts med dipoler, men dessa har han funnit mindre lämpliga för ändamålet.

Några särskilda hjälpmedel såsom preselektorer, konverterar och dylikt anser han inte vara så betydelsefulla när en god trafikmottagare användes men de är givetvis önskvärda i samband med enklare rundradiomottagare. En känslig dubbelsuper tycker han är särskilt lämplig för DX-ändamål, då dessa har god spegelfrekvens, selektivitet och närselektion. Skalorna visar som vanligt inte rätt på samtliga band, det tycks vara

## Eddystone 750 (S750)



Stratton's first true double conversion communication receiver and also the company's first 'slide-rule' set which gave a linear logging-scale of 32 ft.

Using 11 valves it had 1 R.F. stage, a tuneable converter to the first I.F. of 1620 kc/s, straight into a fixed frequency changer with a second I.F. of 85 kc/s and variable selectivity. Range 32 - 1.7 mc/s and 1465 - 480 kc/s.

Production run 2054.



Here are some links to a few good start pages for those seeking information about the history of Eddystone: <https://eddystoneusergroup.org.uk/historical/the-history-of-eddystone-radio/>

[https://www.gracesguide.co.uk/Eddystone Marine Radio](https://www.gracesguide.co.uk/Eddystone_Marine_Radio)

For those interested to see all post-war models produced by Stratton's, here is an interesting survey of their models: [http://www.radiomanual.info/schemi/Surplus\\_Civil/Eddystone\\_post-war\\_models.pdf](http://www.radiomanual.info/schemi/Surplus_Civil/Eddystone_post-war_models.pdf)

## DX-spalten KV-DX i Radio och Television



Börge Eriksson skrev under många år DX-spalten KV-DX i Radio och Television och ett exempel på vad man kunde hitta där är denna notis:

Detta är en verklig QSL raritet: **Radio La Plata**, som ligger i Sucree, sänder på 30,88 m, men är tyvärr mycket sällan hörd, då den stänger redan kl. 2330.

Den hade dock en hörbar period i juni 1956 och svarde då den jände Skåne-DX-aren Kjell Ekholm, Malmö.

/Börge Eriksson i Radio Television 1961 nr 5.

## Interesting article: Airspy youloop

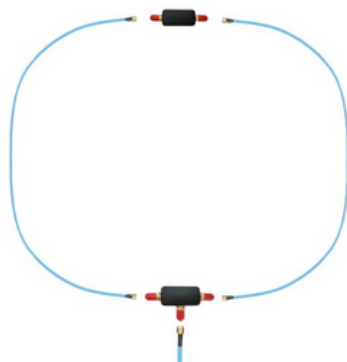

Youloop is one of the most discussed Moebius loop type that offers exceptional noise cancelling of more than 20 db.

The recent days I have tested in big detail the operations between the original and a clone after my homebuilt design was a disaster.

Text with more than 25 pictures and photos. Please read my article:

<https://zachs-radiopage.blogspot.com/2022/05/rx-and-comparing-youloop-clone.html> and all my related articles (3) here: <https://zachs-radiopage.blogspot.com/search/label/youloop>

Original idea: <https://airspy.com/youloop/>  
(Zacharias Liangas)



## Apportkastare / The "Lucky Launcher II" Dummy Launcher



vägar (högt) och hyggen (långt och högt). Det finns en stor nackdel och det är att det smäller högt. I videon har jag modifierat ljudet och gjort smällen högre. Men hörselskydd är bra.

(Tjingeling, Lennart Deimert)

Jag är också medlem i SK5SM - Motala Sändaramatörer. I lördags för en vecka sedan hade vi en s.k. antennedag. I min ägo har jag en antennkanon som är lite utöver det vanliga. Går högt och långt. Olika starka krutladdningar. I videon skjuter en av besökarna en lina lite snett uppåt.

Kanonen är egentligen en s.k. "Dog Gun" - eller "apportkastare" på svenska. Den används till träning av hundar för fågeljakt. Finns att köpa i Sverige. Se <https://svensk-jakt.se/hund/apportkastare-med-pistolgrepp/>

Nu är ju inte det lika viktigt att få upp antenner högt vid DX-ing. Men jag har varit behjälplig med dragningar över

## Two interesting QSL's from the past:

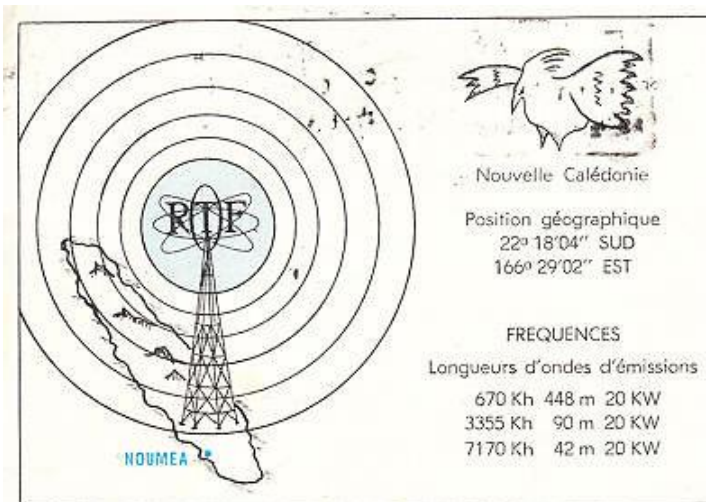

QSL 1970 from RTF Nouvelle Calédonie



TGW - Radio Nacional La Voz de Guatemala – 1938

[https://nationalradioclub.org/QSLs/Geary/SW/SW\\_CA/geary-Guatemala-TGWA.pdf](https://nationalradioclub.org/QSLs/Geary/SW/SW_CA/geary-Guatemala-TGWA.pdf)

*In my opinion is this one of the most beautiful QSL's ever. /TN*

More interesting Guatemalan QSL's can be found here: <http://www.dallasadmall.com/swlqsl/guatemalamain.htm>

## DX nostalgia by RFK

Hello my friends. While we simply cannot forget what is happening around us right now I thought we should have our regular dose of DX nostalgia. Actually the present Swedish Minister of Defence, Peter Hultqvist, used to be a DX-er. I don't know if he is still active – maybe he has other things to think about right now. Two Russian fighters and a surveillance aircraft have come far too close without actually entering the Swedish airspace and PH is not happy about that. At the same time the big NATO exercise BALTOPS 22, including Sweden and Finland, is taking place in the Baltic region. Vlad's "special operation" in Ukraine is still going on and the blockade of the port of Odessa is causing starvation in other parts of the world as grain can no longer be exported. On top of it all Vlad can now charge a much higher price on gas and oil to those who are ready to buy. All in the name of supply and demand. Each and every day there are numerous casualties in this "special operation" on both sides. And all this just because of one madman.

The whole thing is simply crazy and I can't understand why Vlad hasn't already been removed. But hopefully the matter will be settled very soon.

Yes, about DX nostalgia.... Something which is indeed great nostalgia for every DX-er is old DX magazines. They are perfect to read in front of your radio while you are listening, dreaming of what you could hear way back then. So I thought we should take a look at a few Swedish DX magazines. At first let's have a look at Nattugglan (The Night Owl). It was published by the Scandinavian DX Club and was a very professional looking magazine for its time. Here is the cover of the January 1949 edition.

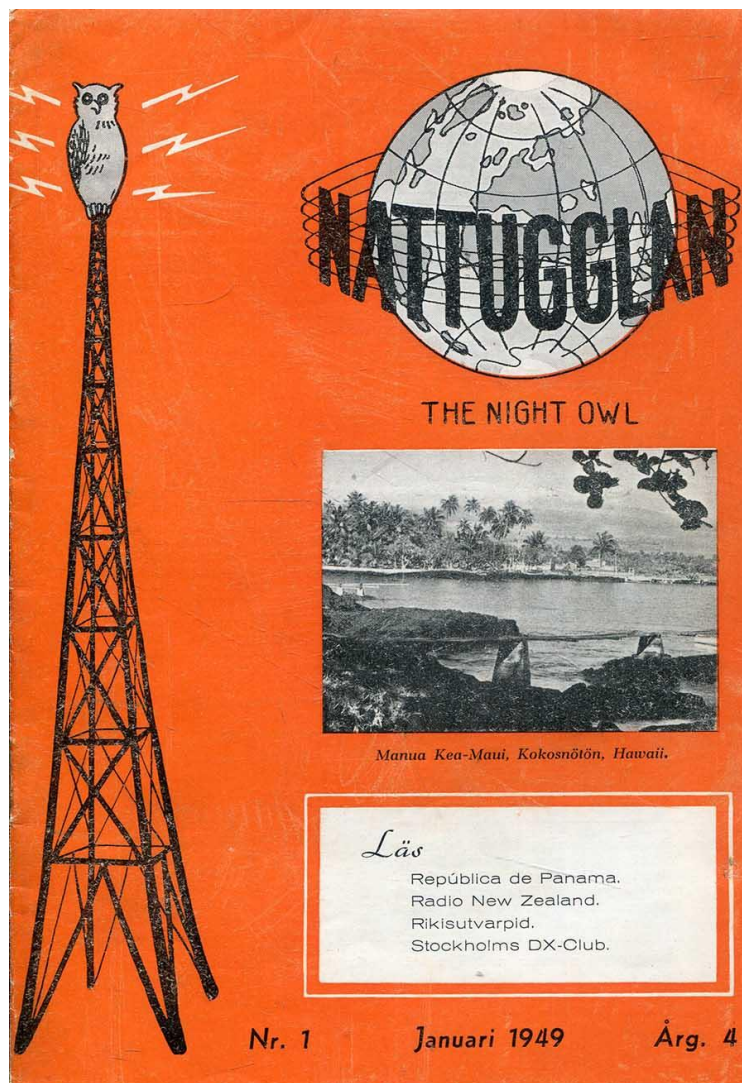



The Scandinavian DX Club had some international members and some section of Nattugglan were published in English. Here is a report from wellknown Israeli DX-er Bert Bluman.

NATTUGGLAN

## 510 Herbert M. Bluman reports

(All times GMT)

CHINA: New Nanking XGSH 9605 kc/s, relays XGOA 09.00—15.15, parallels XGSO and XGSN.

BORNEO: "Radio Pontianak" YCN3 — 8090 kc/s — was heard Sunday 21st Nov. until 15.30 GMT.

PALESTINE: new frequency for RCA Tel Aviv is 10525 kc/s heard around 20.00 KMT contact with WRD2 Tangiers and TYF Paris.

KENYA: FBS Mombasa, which had been off the air for a fortnight, is back, on 7200 kc/s, 03.59—05.00 & 09.00—19.00 GMT. Good reception mornings, but drowned in QRM afternoon & evening.

NEW ZEALAND: ZL3 and ZL4 have for the last few days again be heard relaying the early morning home programme from 1800 GMT onwards. News are read at 19.00, BBC news relayed at 20.00. ZL3 fine signal but ZL4 almost drowned out by WNRE.

MOCAMBIQUE: Present sked of English language programmes from Lourenço Marques is: weekdays 05.00—08.00 & 12.00—16.00, Sundays 07.00—16.00 over CR7BE on 9705 kc/s — daily 16.00—21.00 over CR7BU 4932 kc/s & CR7AB 3490 kc/s.

NORTHERN RHODESIA: Lusaka ZQP has adjusted frequency from 9710 to 9715, presumably to avoid interference from CR7BE which has moved up to 9705 kc/s. Present sked is weekdays 15.00—18.02, opening at 15.00 with a news summary in English, and closing after repeating the weather forecast at 18.00 with "God Save the King" — off at 18.05. On Sundays from 15.30—16.30.

INDONESIA: On 11095/11100 kc/s transmitters relaying YHN Djogjakarta until 15.30. Unidentified. On 7300 kc/s unidentified tx heard until sign off at 15.00. Call is "Radio Indonesia??" Progr. different from Batavia. And now I am "signing off" for the

present, and hope to be back in about three months with some new DX items. Until then here is wishing all my friends in Sweden Merry Christmas and a Happy New Year, FB DX, 73s and all the best

Bert Bluman.

Many Swedish DX-ers would argue that the best Swedish DX magazine of the 1960s was Malmö-DX-aren, published by Malmö Kortvågsklubb. It had a wealth of loggings and DX news and often interesting articles. It also included a ham section.

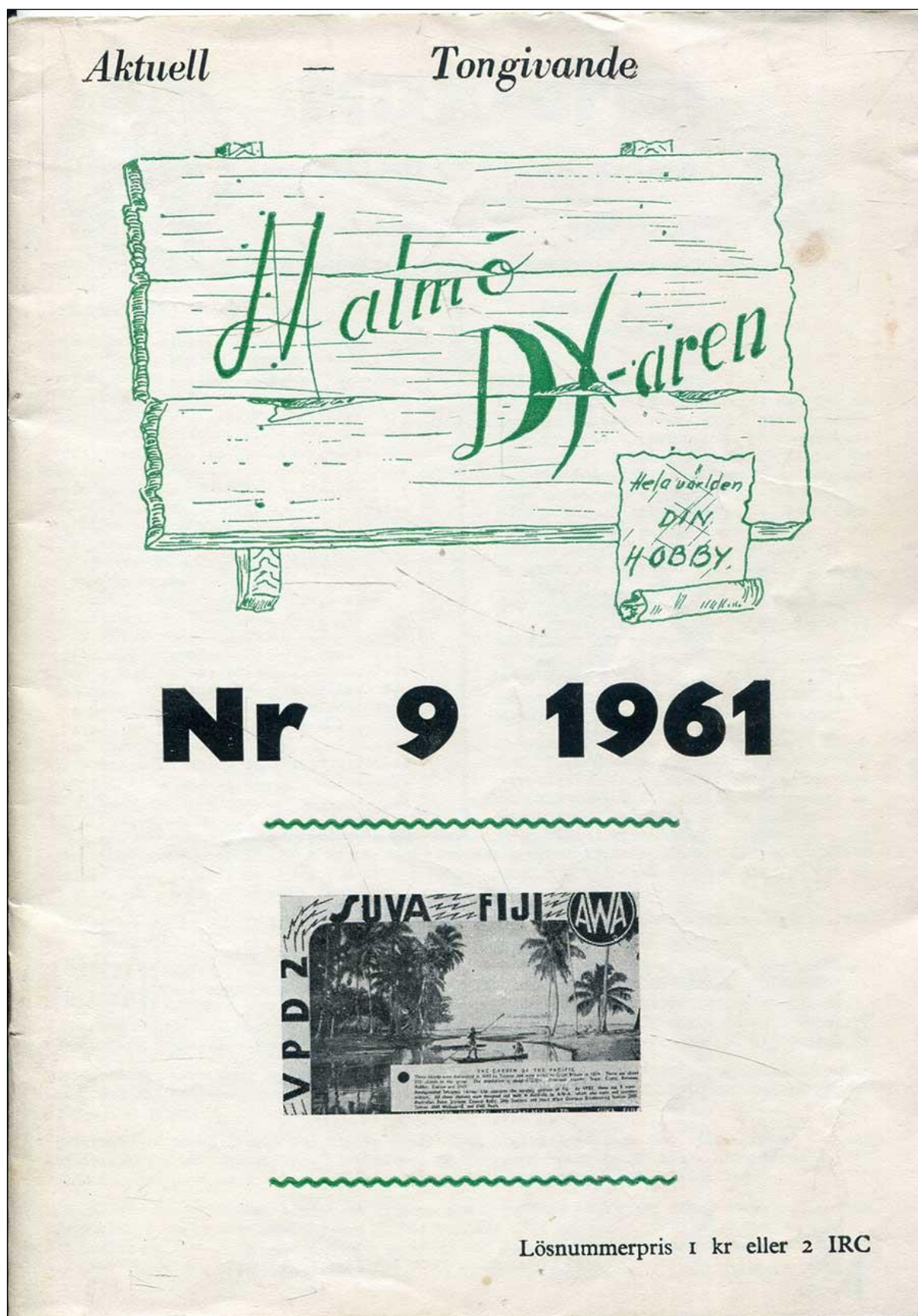



The Central America DX section of Malmö DX-aren. Yes, it is in Swedish but anyway quite interesting to see what could be heard from Honduras on SW in 1961.

-3-

9/61

## CENTRAL AMERICA DX

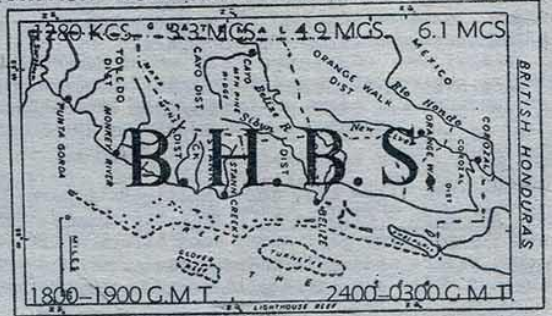

**BRITISH HONDURAS BROADCASTING SERVICE**

**B.H.B.S.**

Servicio Radiodifusor de Honduras Britanica

**REP. DE HONDURAS**

Vi fortsätter så med slutet av DX landet Honduras och passar också på att visa QSL-et från Brittiska Honduras här bredvid.



**HRW2 -"Rádio Monserrat", Tegucigalpa - 6020 kc/s. (1 kW):** En fin gammal DX-station som förr i tiden hördes rätt så bra och de svarade då ganska säkert på rapporter med ett stiligt QSL-brev. Tyvärr är det nu ganska svårt att förmå stationen att svara på rapporter. Mina båda rapporter besvarades tyvärr aldrig. Vem av er har deras QSL ?

**HRRH5 -"La Voz de Occidente", Santa Rosa de Copán, - 9543 kc/s (0,5 kW):** Denna verkliga "raring" avlyssnades sommaren 1958 på 9545 kc/s av den icke okände DX-aren Bengt Dalhammar, Lidingö och hans rapport besvarades prompt med långt personligt brev. Trogligtvis är Bengt fortfarande ensam om QSL-rariteten, ty stationen är sannerligen svårhördd p g a den nästan omöjliga frekvensen.

**HRVS -"La Voz de Suyapa", Tegucigalpa, - 4940 kc/s - 9705 kc/s (1 kW):** Stationen rapporterades i slutet av feb. på 4940 kc/s. Stationens direktör Sr. Juan Pablo Guillet svarade med brev vari han meddelade att KV, MV (1540 kc) samt FM (105 Mc) är av märket Gates och på 1 kW effekt. Sistnämnda sändare tjänar även som länk mellan studio och sändare som ligger ung. 10 km ifrån varann. Sändarna är belägna i närheten av den hondurenska nationalhelgedomen som är vigd för "Vår Fru av Suyapa", Honduras skyddshelgon. Dir. bifogade också ett mycket snyggt vykort som visade bilden av just "Jungfrun av Suyapa" (QSL=se förra numret). Red fick tidigare från HRQN en mycket snygg sidenduk som likaså visar "Suyapas Jungfru". Stationen meddelade att de fått rapporter tidigare och då ifrån Frankrike och Tyskland men aldrig så långt ifrån som Sverige. Allt enligt 309 L-E Johansson, Göteborg som alltså är Sverige-etta. Grattis.

**HRYN4 -"La Voz del Merendón", San Pedro Sula, - 6060 kc/s (0,3 kW):** Stationen avlyssnades med god hörbarhet särskilt år 1958 av bl a Göte Johansson i Skärby, men jag har inte hört att någon fick stationen verifierad.

**HRNQ4 -"Rádio Morazán", Tegucigalpa, - 6085 kc/s (1 kW):** Uppges nu vara inaktiv på de här frekvenserna: 3395, 4815, 9670, 11860, 25710 kc/s. Samtliga 1 kW.

**HRN -"La Voz de Honduras", Tegucigalpa, - 5873 kc/s (5 kW):** Relativt ofta hörd i Sverige och har hörts hela sommaren i år och hörs nog fortfarande. QSL dock sällsynta. Endast ett QSL känt - Jan Pettersson. Please infos.

**HRP1 -"El Eco de Honduras", eller "Rádio Periódico", San Pedro Sula, - 5995 kc/s (1kW)** Fin hörighet och har hörts sedan 1958 vid några tillfällen. Inga QSL kända.

**HRTL2 -"Rádio Tegucigalpa", Tegucigalpa, - 6035 kc/s (1,5 kW):** År 1959 dök denna station plötsligt fram i eterhavet och man kunde vid denna årstiden på morgnarna höra den nya stationens trevliga musikprogram. Flera rapporter förblev obesvarade, men Cup-Sven Erik Larsson fick visst QSL? Please infos.

**HRMH5 -"La Voz del Junco", Santa Bárbara - 6075 kc/s (0,5 kW):** Också en "raring", som vid flera tillfällen avlyssnades på flera platser i vårt land. Men ack, besvikelsen är stor ty någon verifikation kom aldrig. Har någon fått QSL därifrån ?

**HRIC -"Rádio Continental", San Pedro Sula - 4770 kc/s:** En helt ny station som avlyssnats vid flera tillfällen, men hur är det med QSL därifrån ?

Fortsättning på nästa sida och start för nya avdelningen LA-DX-NYTT:



The magazine DX-aren was published by the short-lived Sveriges DX-Riksklubb in the 1960s. The cover shows the m/s Bon Jour, home of Swedish offshore station Radio Nord. As you know the ships' name was later changed to the Mi Amigo and she served for several years as a radioship housing Radio Atlanta, Radio Caroline and others.

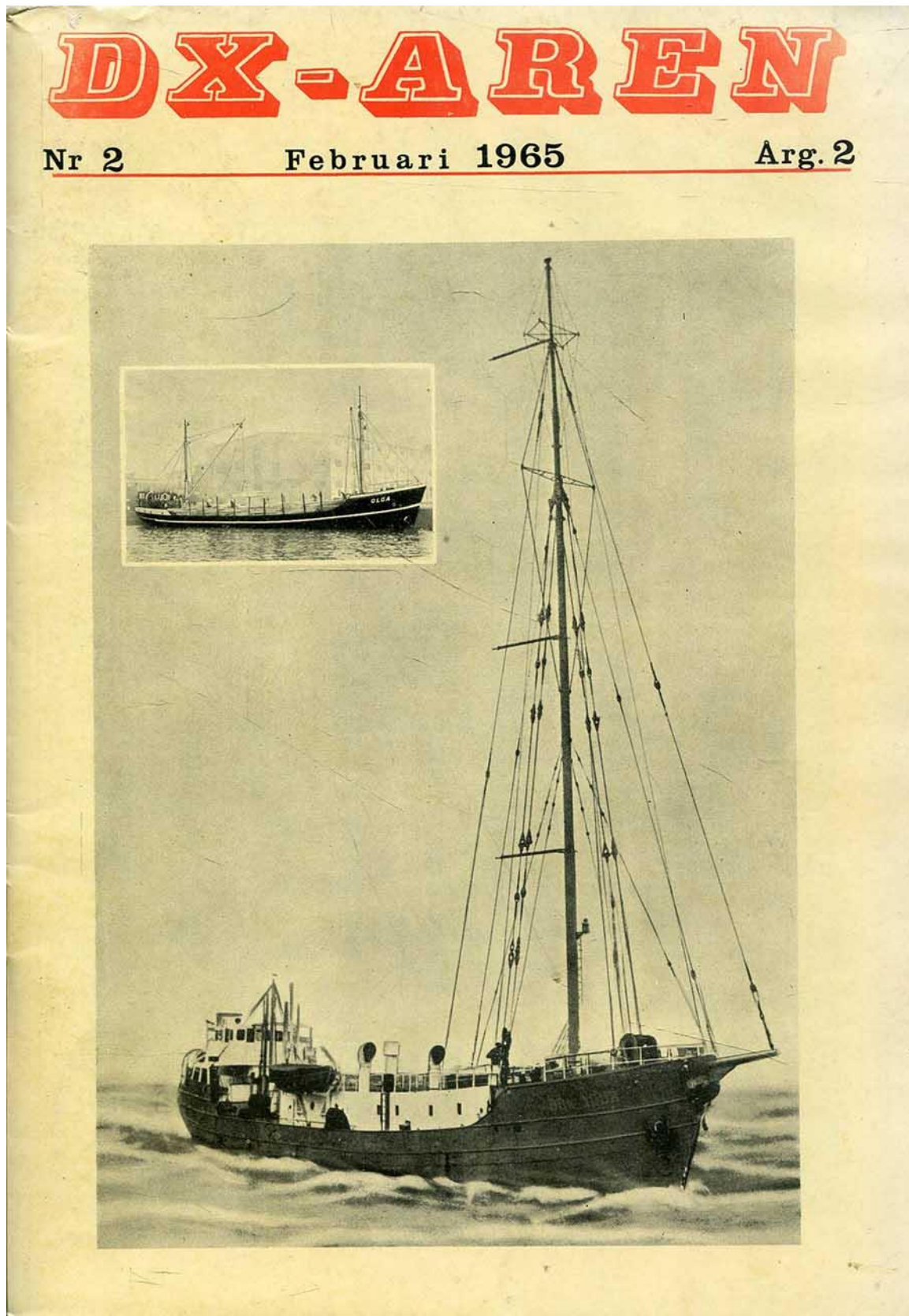



The first DX club yours truly joined was Sveriges Radioklubb. Their magazine DX radio was much modelled after Nattugglan and contained lots of loggings, news and articles. The issue 6-1964 had a couple of pics from the Tonga radio station on the cover plus a presentation of the station inside the magazine.

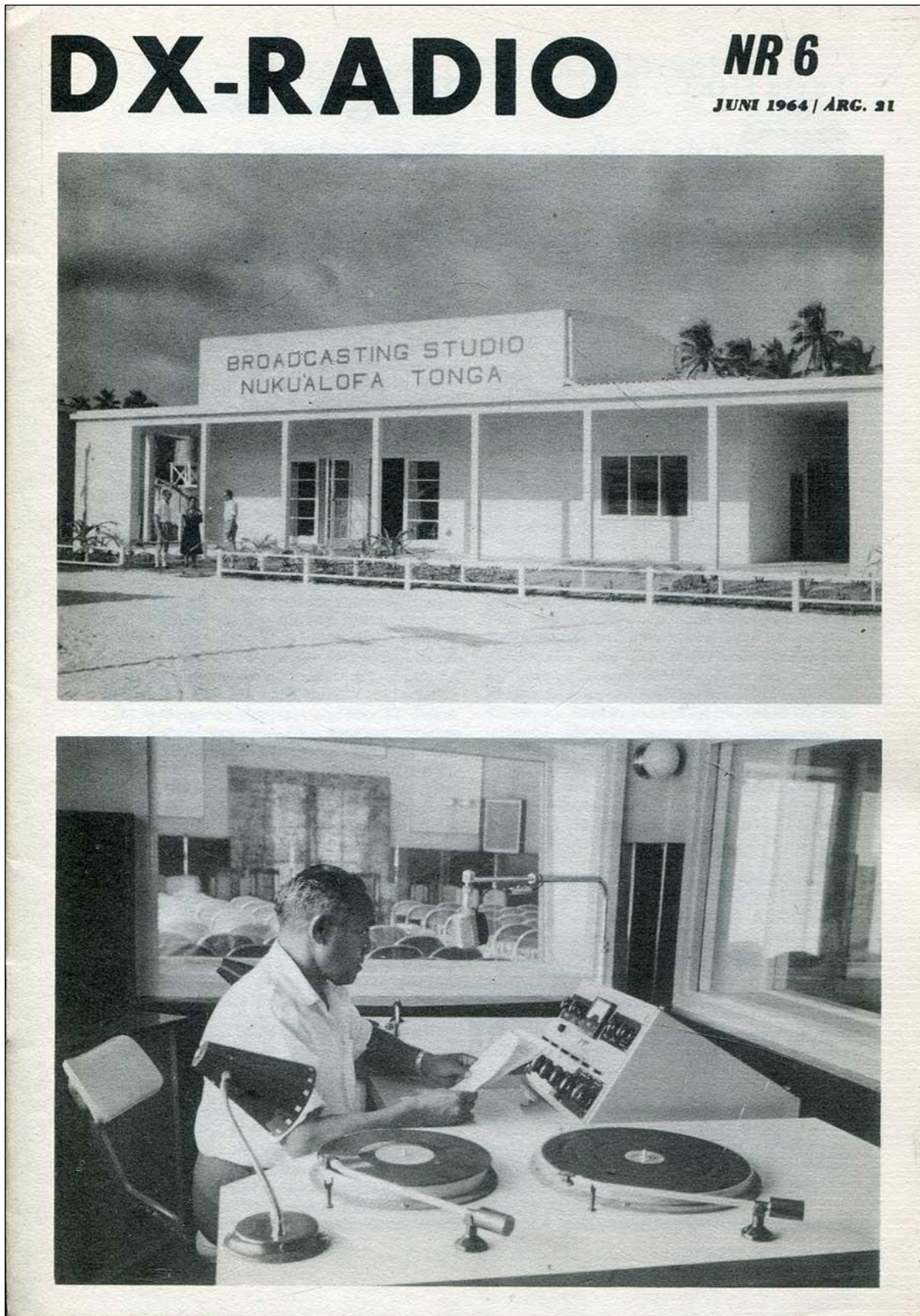



Finally, if you have ever wondered what SWB looked like from the start you need not wonder any longer. The basic idea was to get information about loggings, station news. QSL news etc out to the members as quickly as possible. You could say the layout has improved somewhat over the years.... You are always welcome to submit DX nostalgia to info @ rock.x.se. It can be scans of old QSLs, pennants, clippings, memorabilia or why not some rare old DX magazine? Please let me hear from you. Take care and stay safe.

DX-bulletin nr I2 /oj, vad tiden rinner iväg! / 30-9-61

Editor: Jan Pettersson, Kyrkogårdsgatan 39B  
Uppsala. STOPPDATUM: lörd. ff.m.

Alla tider SNT!!

Haj chaps!

Trots de få bidragen kommer faktiskt en bulletin. En honnör åt de få tappra!! En särskild eloge åt Kjell Bengtsson, som donerat hela IO:- till förmån för bullens finansier, som ej är de bästa. Hi!! Ett varmt tack!! CX-en verkar nu komma igen för Asiendx enligt tipsen att döma. Hoppas Alla vill höra av sig till nästa gång med Kuvert och QSL-anmälningar o. dyl, även om lyssnaraktiviteten ej varit den bästa.

Editor tar sig friheten att inleda med följande enkla rader fred. kväll:

QSL som kommit: Continento har svarat med sitt fula kort 5030. Dupplett har kommit från Haute Volta medan somliga inte får ett dugg, hi! / R. Atlantida, Peru har svarat med brev 5120. En annan peruan som har svarat är Radio Miraflores med pers. brev från programdirektören med frim. i och ett vykort och vädjan om korrespondens. 6330 är fq. Sämre med Kortvägsaktivitet: När Bengt Eriksson, Tore Larsson, Nils Thalín och Lennart Alarik lämnat mitt QTH för att sova, hörde Thord Knutsson och red. call o ID på min OID colombian 4575: 24-9 04.27 komx call: Radio Buenaventura. Fick någon ID tidigare?? Red. undrar optimistiskt nog på Sverige-etta om de svarar!?. På sönd, kvällen hördes en mystisk fransktalande stn på A 3355. De anropade Radiodiffusion Television Francaise och hördes 17.25-18.00 då en massa QRM kom på fq. Kan det vara Reunion eller Komorererna som har flyttat?? Det vara nämligen goda ex mot ÖST-Afrika när stationen gick fram i sönd. samt några andra kvällar förra veckan! Mauritius har också tittat fram på 3335 några kvällar -17.40- Dock ganska dålig hörbarhet på OID 3355 och Maurit. Eventuellt har Radio Luz, Ecuador hörts 3945. Se nedan under LA!!

OBS

OBS

Nils Thalín har hört specialprogrammet till Sverige, från Radio Junin. Gärdebylåten och hälsningar stod på programmet. God hörbarhet första utsändningen!! Belize har hörts en gång 04.55. 3300 och QSA/K2-3. Ondas Azuayas 4980 hörs allt som oftast till close 05.30. Transmisora Caldas kan sedan höras till close 06.00 på 5020. QSA3-4. QSL har kommit från VOA Theasaloniki.

Lennart Alarik kommer stickande med: QSL från Radio Atlantida, 5120 och Radio Nuevo Mundo 5990. Lennart har även han hört OID fr. talande på 3355-3360 och Mauritius 3335 vid 17.30 och en halvtimme framåt.

En Ecuadorstation har hörts på A 3945. Talade flera gånger om Radio Luz, men vid jämnt klockslag hördes efter gong: Radio....., ESMERALDAS!!! Eftersom Radio Luz ligger i Ambato torde det EJ vara denna station!! Troligen inte heller Radio Iris, säger Lennart. HJÄLP!! Stationen hörs bäst 03.00-04.00 och har ibland svår CW. QSA2-3-4.

OBS

Leif Wickström, Enskele har ej varit aktiv på kortväg och rapporterar endast ett QSL: La Voz de Gran Colombia som även bifogade ett standar.

Jan Tunér, Nässjö har bara varit aktiv på MU och har fått svar från: Radio El Mundo, CBI, CBA, WEZE, CKEC. Don sistnämnda Europa-2:a. Grattis!!!!

Ellmann Ellingsen, Norge rapporterat haver: Radio Sanaah 18.30-19.10 5.85 QSL: ENBC, Togo 5047. Grattis!! Det tar sig!! red.

Odd Stensrud, Norge kommer med tips: Santa Fé 4965 QSA 4-5 // Junin 4930 o 4 R. Dif. Nac Ecuador 4940 med fin styrka. Alla stns loggade 05.00-06.30. QSL: Abidjan, Habana, RRI, och Nuevo Mundo 5990. Go on, please! red. 90 länder nu!

Lars Hennigsson, Backaryd meddelar att fq på hans OID Angola i förra nr. är 4915A Den har hörts ett par kvällar efter 19-9 men ganska svagt. 10.00-4.30 Pakistan QSA3-2 03.04 25-9 // 4955 Senegal 23.20 QSA4 4.55 R. Dif. Nac. de Colombia QSA4-5 03.30-04.00. / Ligger troligen i Bogota. Heter verkligen stationen detta?? red. // 4960 Sucre 01.20 QSA3-2 4965 Santa Fé QSK2-3v 02.32 // 11880 Splendid QSA3-4 02.00 Radio Habana 23.00 QSA4 11875 // QSL: R. Soc. de Feira de Santana 4765 med brev/tryckt o handskrivet/ märke samt en snygg vimpel. LH vill ha sitt brev översatt. Skriv till honom den som kan: LH. HeMan. Backaryd. !!!